



OmniView™
4-Port
USB KVM
Switch
User Guide

P73428

F1D104-USB

Belkin Components

F1D104-USB - OMNIVIEW™ SE 4-Port

READ BEFORE INSTALLATION

Tech Notes:

- 1) Windows 98/98 SE systems
 - HID (Human Interface Device) driver must be installed **prior** to using the USB KVM switch. To install the HID driver, first connect a USB keyboard and mice directly to computer (before installing KVM switch) then follow the Windows installation instructions, this will install the HID device driver and allow the use of the KVM switch. Failure to do so may result in Windows not being able to detect keyboard and mouse.
 - If a mouse recognition error is displayed during system boot:

*“Windows did not detect a mouse attached to the computer.
You can safely attach a serial mouse now.
To attach a mouse to a PS/2 mouse port, you must first turn the computer off”*

Press the **Tab** key once to select the check box
Press the **Space bar** once (which will place a check in the box “Do not show this message again”)
Press the **Enter** key once and Windows will continue to boot and will then recognize the mouse.
- 2) Windows 2000
 - Switching channels while a USB storage device is connected to the OmniView™ will prompt the message:

“the device was removed unsafely”

Before switching channels, double click on the “**Unplug or Eject Hardware**” icon, located in the taskbar. Highlight the storage device(s) and click on the Stop button. This will prevent the error message from appearing.
- 3) Beep sound can be turned on or off by pressing the scroll lock key twice then press the “S” key.
- 4) Autoscan, Hot Keys, & OSD will only work with a PS/2 Keyboard
- 5) The computer will take 1~3 seconds to redetect the connected USB devices when the channel is switched.
- 6) **WARNING:** Do not switch channels when a connected data storage or acquisition device is in operation. Failure to do so will result in system error and/or loss of data.

Introduction

Thank you for purchasing the Belkin Components® 4-Port USB KVM Switch! Now you can control up to four different USB computers on any operating system! With exclusive Time-Delay Technology, USB switching is seamless and error-free. The built-in USB to PS/2 converter allows users to work on a standard PS/2 keyboard and take advantage of hot key switching and On-Screen Display. And with video bandwidth capable of 1600 x 1200 @ 85Hz, images are clear and distortion-free. No other manufacturer makes a better KVM switch!

NOTE ON RECOMMENDED OPERATING SYSTEM COMPATIBILITY

Any USB-enabled operating system such as Windows® 98, Windows® 98SE, Windows® 2000, Mac® OS 8.x or higher. Windows® 95 and OSR2.1 are not recommended because of immature USB support.

Package Contents

- 4-Port USB KVM Switch F1D104-USB
- 12VDC, 1.6A switching power adapter
- This manual
- Registration card

Product Detail

Front View

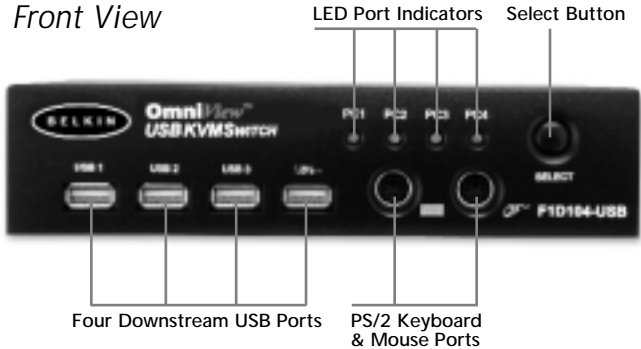

Rear View

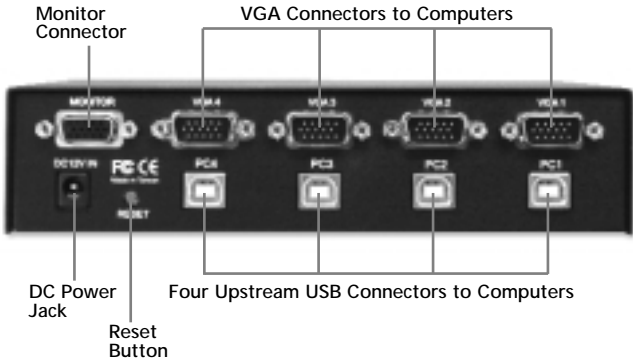

Installation Instructions

Please follow these instructions carefully to ensure proper system functionality.

Do not power down any of your computers, and do not unplug any PS/2 or USB keyboard or mouse device just yet. Doing so may cause you unnecessary reboots and other hassles.

First, connect your monitor to the monitor port at the back of the USB KVM.

Rear View USB KVM

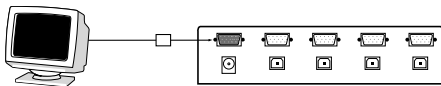

Then, plug in the power adapter to an AC outlet and plug the power jack into the USB KVM.

Rear View USB KVM

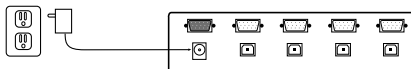

Connect your keyboard and mouse to the USB KVM. You can use either USB or PS/2 or both. However, we recommend using a PS/2 keyboard, and either type of mouse. Using a PS/2 keyboard allows you to control the KVM switch through hot keys and On-Screen Display.

Installation Instructions (continued)

Front View USB KVM

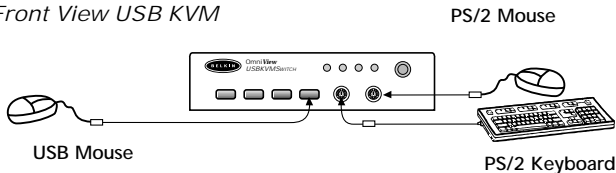

Connecting a Windows-based PC to the USB KVM Switch

Using a USB KVM Cable Kit (Belkin F3X1895-XX), connect the VGA and USB cables to an empty port at the back of the USB KVM.

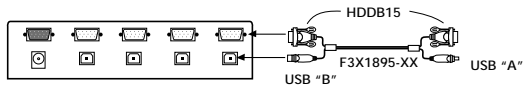

Connect the other ends of the USB KVM Cable to the appropriate ports at the back of your PC. When connecting the USB cable, plug it into an unused USB port. If all USB ports are occupied, unplug a USB device that is NOT a keyboard or a mouse. You need the keyboard and mouse to control Windows® when it starts detecting the USB KVM Switch components.

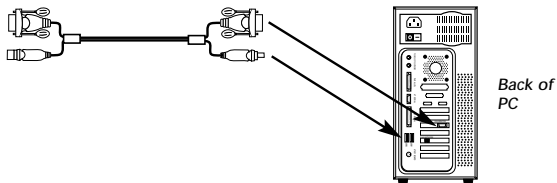

Installation Instructions (continued)

Once you have plugged in the USB cable, Windows® will detect the built-in 4-port hub, PS/2 Keyboard, and Mouse I/F. Even if Windows® asks for drivers, the drivers are built in. The USB KVM uses standard HID-Class (Human Interface Device) drivers. So all you need to do is keep hitting "NEXT" until Windows® loads the drivers. Only when the drivers are loaded can you start using the devices connected to the USB KVM Switch.

See below:



Click **NEXT**

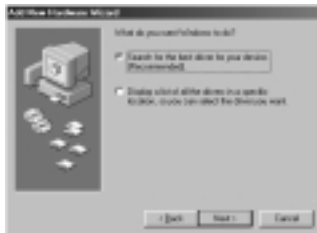

Click **NEXT**

Installation Instructions (continued)

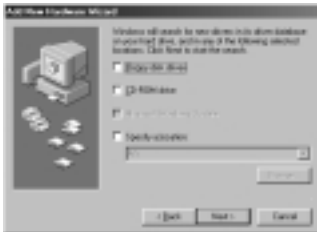

Make sure no boxes are checked. Click **NEXT**

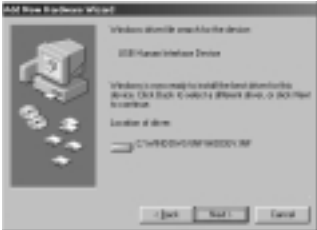

Click **NEXT**

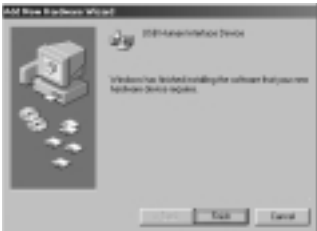

You're done! Click **FINISH**.

Installation Instructions (continued)

Connecting a Macintosh® to the USB KVM Switch

Using a USB KVM Cable Kit (Belkin F3X1895-XX), connect the VGA and USB cables to an empty port at the back of the USB KVM.

Rear View USB KVM

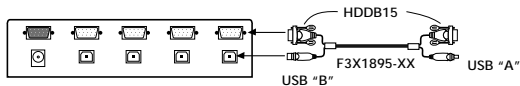

Connect the other ends of the USB KVM Cable to the appropriate ports at the back of your Mac. When connecting the USB cable, plug it into an unused USB port. If all USB ports are used up, unplug a USB device that is neither a keyboard or a mouse.

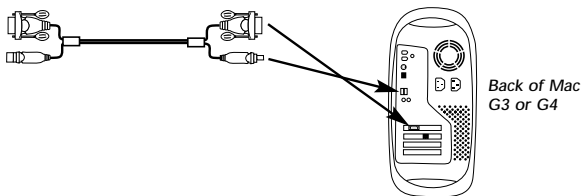

Once you have plugged in the USB cable, Macintosh® OS will detect the built-in 4-port hub, PS/2 Keyboard, and Mouse I/F. The USB KVM uses standard HID-Class (Human Interface Device) drivers so no other action is required.

Usage

Connecting USB Devices to the built-in 4-Port hub

When you connect any USB device to the 4-port hub, that device will be switched when you switch computers. For instance, a USB Camera will be connected to computer 2 when you switch from computer 1 to computer 2. This is fine for many devices, but not suitable for storage devices such as LS-120 drives and Zip® drives because you cannot dynamically switch ports and disconnect a mounted storage device when it is in use by the operating system.

For instance, if you are on computer 1 and have a file open that is stored on a Zip drive connected to the USB KVM, and then switch to computer 2, you will get an error message on computer 1 saying that the file may be lost or corrupted.

The same is true when you are using a streaming device such as the Belkin VideoBus USB Video Capture device. You can switch from one computer to the next only if the VideoBus is no longer in use by the first computer.

Selecting which computer to operate can be done by either On-Screen Display, the SELECT button, or through keyboard hot key commands. You will notice that after the USB KVM switches to another computer, the mouse will be inoperative for about 1-2 seconds. This is a normal operation ensuring that proper USB synchronization is established.

NOTE: You must have a PS/2 keyboard in order to use the On-Screen Display and/or keyboard hot keys.

Usage (continued)

The SELECT Button:

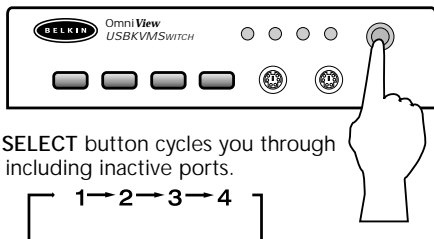

Pressing the **SELECT** button cycles you through all the ports, including inactive ports.

Keyboard hot key commands (REQUIRES PS/2 KEYBOARD):

You can also conveniently command the USB KVM to switch ports through simple keyboard key sequences. To send commands to the USB KVM, the **SCROLL LOCK** key must be pressed twice within 2 seconds. You will hear a beep for confirmation. Below are the different commands:



Switch to **PREVIOUS ACTIVE** port



Switch to **NEXT ACTIVE** port



Directly switches to port **Y**

You can switch directly to any port by giving the USB KVM the **PORT** number. For instance, if you press **[SCROLL LOCK] [SCROLL LOCK] [2]**, the computer on **PORT 2** will be selected.

Usage (continued)

AutoScan Mode:



Enable AutoScan mode

To enable AutoScan mode, press [SCROLL LOCK] [SCROLL LOCK] [0]. In AutoScan mode, the USB KVM remains on one port for a number of seconds, before switching to the next. This time interval is set in the On-Screen Display menu.

NOTE: There is no mouse or keyboard control in this mode. This is necessary to prevent errors. Otherwise, if the user is moving the mouse or using the keyboard when the USB KVM switches to the next port, data flow is interrupted and will cause erratic mouse movement and/or the wrong characters to show up when using the keyboard.

To exit **AutoScan mode**, press the **SPACEBAR**.

On-Screen Display Menu Control:



Enable the On-Screen Display menu

To enable the On-Screen Display, press [SCROLL LOCK] [SCROLL LOCK] [SPACEBAR]. Immediately, the On-Screen Display overlay screen appears. This screen is generated by the USB KVM and does not affect your computers or running software in any way.

Usage (continued)

The main On-Screen Display menu is shown on the right. It shows the currently selected BANK.

If you have only one USB KVM, it will say "BANK 0".

The current selected port is shown in RED.

The current selected port is shown in RED.

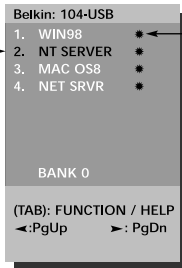

"*" indicates that the computer connected to that port is powered up.

Usage (continued)

- You can navigate through the active ports by using the arrow keys. The On-Screen Display menu will only allow you to move to active ports.

NOTE: If a computer is connected and is powered up, but the On-Screen Display menu does not display a “*”, you will have to RESET the USB KVM to re-detect the powered computers. Simply press the reset button at the back of the USB KVM.

- Pressing the [INSERT] key allows you to rename the port. Press [ENTER] to complete.
- Pressing the [ESC] key exits the current screen.
- To view a different BANK, pressing the [PAGE UP] key goes to a previous BANK, while the [PAGE DOWN] key brings you to the next BANK.
- Once you have selected a computer on the menu, press [ENTER] to switch to its port.
- Pressing the [TAB] key opens the Function menu. In this menu, you can select SCAN TIME and DISPLAY TIME.
- [SCROLL LOCK] [SCROLL LOCK] [DEL] erases all of the names stored in the OmniView™ PRO's memory. The names default back to “Channel 1”, “Channel 2”, etc... You must wait 30 seconds in order for the memory to be reinitialized.

Usage (continued)

SCAN TIME:

SCAN TIME:

Amount of time the USB KVM stays on one port before switching to the next port when in Scan Mode.

DISPLAY TIME:

Amount of time the On-Screen Display Menu or Port Name remains displayed on-screen after making a port selection.

SCAN TIME:

7sec 15sec 30sec 60sec

DISPLAY TIME:

7sec 15sec 30sec 60sec

[↕]: SELECT

(INS): RENAME

(Enter): COMPLETE

(Esc): Exit

Troubleshooting

Monitor/Video Problems:

- Q:** I am getting ghosting, shadowing, or fuzzy images on my monitor.
- A:**
- Check the cables and make sure they are inserted properly.
 - Your resolution and/or refresh rate is extremely high, or your cable is too long. Replace your VGA cables with coaxial double-shielded cables such as Belkin A3H981-XX.
 - Check to make sure that the power adapter is plugged in and is working properly. It must be 12VDC, 1600mA minimum. Make sure the power switch is on.
 - Lower you refresh rate and/or screen resolution settings.

Information

FCC Statement

DECLARATION OF CONFORMITY WITH FCC RULES FOR ELECTROMAGNETIC COMPATIBILITY

We, Belkin Components, of 501 West Walnut Street, Compton CA 90220, declare under our sole responsibility that the product:
F1D104-USB

to which this declaration relates:

Complies with Part 15 of the FCC Rules. Operation is subject to the following two conditions: (1) this device may not cause harmful interference, and (2) this device must accept any interference received, including interference that may cause undesired operation.

CE Declaration of Conformity

We, Belkin Components, declare under our sole responsibility that the F1D104-USB, to which this declaration relates, is in conformity with Generic Emissions Standard EN50081-1 and with Generic Immunity Standard EN50082-1 1992.

Belkin Components Limited Lifetime Product Warranty

Belkin Components warrants this product against defects in materials and workmanship for its lifetime. If a defect is discovered, Belkin will, at its option, repair or replace the product at no charge, provided it is returned during the warranty period, with transportation charges prepaid, to the authorized Belkin dealer from whom you purchased the product. Proof of purchase may be required.

This warranty does not apply if the product has been damaged by accident, abuse, misuse, or misapplication; if the product has been modified without the written permission of Belkin; or if any Belkin serial number has been removed or defaced.

THE WARRANTY AND REMEDIES SET FORTH ABOVE ARE EXCLUSIVE IN LIEU OF ALL OTHERS, WHETHER ORAL OR WRITTEN, EXPRESSED OR IMPLIED. BELKIN SPECIFICALLY DISCLAIMS ANY AND ALL IMPLIED WARRANTIES, INCLUDING, WITHOUT LIMITATION, WARRANTIES OF MERCHANTABILITY AND FITNESS FOR A PARTICULAR PURPOSE.

No Belkin dealer, agent, or employee is authorized to make any modification, extension, or addition to this warranty.

BELKIN IS NOT RESPONSIBLE FOR SPECIAL, INCIDENTAL, OR CONSEQUENTIAL DAMAGES RESULTING FROM ANY BREACH OF WARRANTY, OR UNDER ANY OTHER LEGAL THEORY, INCLUDING BUT NOT LIMITED TO LOST PROFITS, DOWNTIME, GOODWILL, DAMAGE TO OR REPROGRAMMING, OR REPRODUCING ANY PROGRAM OR DATA STORED IN OR USED WITH BELKIN PRODUCTS.

Some states do not allow the exclusion or limitation of incidental or consequential damages or exclusions of implied warranties, so the above limitations of exclusions may not apply to you. This warranty gives you specific legal rights, and you may also have other rights that vary from state to state.



belkin.com

Belkin Components

501 West Walnut Street
Compton • CA • 90220 • USA
Tel: 310.898.1100
Fax: 310.898.1111

Belkin Components, Ltd.

Unit 13 • Gatelodge Close • Round Spinney
Northampton • Northants • NN3 8RX
United Kingdom
Tel: +44 (0) 1604678300
Fax: +44 (0) 1604678330

Belkin Components B.V.

Diamantlaan 8 • 2132 WV
Hoofddorp • The Netherlands
Tel: +31 (0) 235698765
Fax: +31 (0) 235612694